

For Health Hazard Applications

Job Name _____
 Job Location _____
 Engineer _____
 Approval _____

Contractor _____
 Approval _____
 Contractor's P.O. No. _____
 Representative _____

LEAD FREE*

Series LF919 Reduced Pressure Zone Assemblies

Sizes: ½" – 2" (15 – 50mm)

Series LF919 Reduced Pressure Zone Backflow Assemblies are designed to protect potable water supplies in accordance with national plumbing codes and water authority requirements. This series can be used in a variety of installations, including the prevention of health hazard cross-connections or for containment at the service line entrance.

This series features two poppet style check valves, replaceable check seats, with an intermediate relief valve. Its compact modular design facilitates easy maintenance and assembly access. Sizes ½" – 1" (15 – 25mm) shutoffs have tee handles. The LF919 features Lead Free* construction to comply with Lead Free* installation requirements.

Features

- Separate access covers for the check valves and relief valve for ease of maintenance
- Top entry-all check internals easily accessible
- All rubber elastomers of chloramine resistant material
- Check valve poppet assemblies are fully guided by innovative plastic seat guide
- Replaceable push-in check valve and relief valve seats eliminates threads from the water way
- EZ twist relief valve cover quarter-turn locking joint captures the spring load during repair to facilitate disassembly
- Innovative check valve plastic cover bushing provides trouble free guiding of the check valve poppet
- Bottom mounted relief valve provides reduced installation clearances
- Compact, space saving design
- No special tools required for servicing
- Top mounted test cocks for ease in testing and reduced installation clearances
- Standardly furnished with NPT body connections

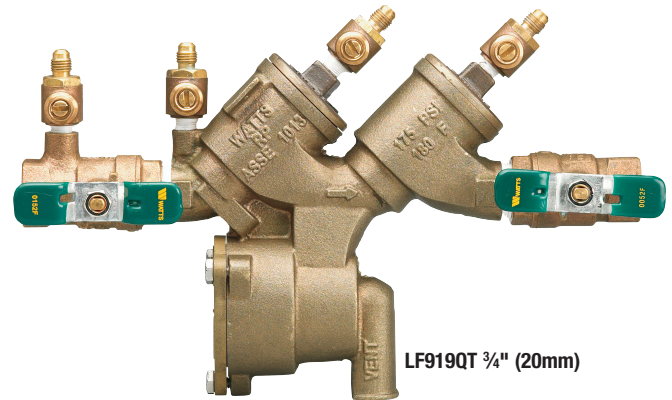

Specifications

A Reduced Pressure Zone Assembly shall be installed at each potential health hazard location to prevent backflow due to back-siphonage and/or backpressure. The assembly shall consist of a pressure differential relief valve located in a zone between two positive seating check valves. Seats and seat discs shall be replaceable in both check valves and the relief valve without the use of special tools. Service of all internal check valve components shall be through top mounted access covers threaded to the main valve body. The check valve poppet assembly shall be guided via the use of a corrosion resistant plastic guide. The check valve and relief valve seats shall be push-in type. The relief valve cover shall be secured with stainless steel bolts and shall utilize a quarter-turn locking joint to capture the spring load of the relief valve. The relief valve shall have an internal sensing line to sense the inlet water supply. All rubber elastomers shall be of chloramine resistant material. The assembly shall also include two resilient seated isolation valves, four top-mounted resilient seated test cocks and an air gap drain fitting. The Lead Free* Reduced Pressure Zone Assembly shall comply with state codes and standards, where applicable, requiring reduced lead content. The assembly shall be a Watts Series LF919.

Now Available
WattsBox Insulated Enclosures.
 For more information, refer to literature ES-WB.

NOTICE

Inquire with governing authorities for local installation requirements

*The wetted surface of this product contacted by consumable water contains less than 0.25% of lead by weight.

Watts product specifications in U.S. customary units and metric are approximate and are provided for reference only. For precise measurements, please contact Watts Technical Service. Watts reserves the right to change or modify product design, construction, specifications, or materials without prior notice and without incurring any obligation to make such changes and modifications on Watts products previously or subsequently sold.

WATTS®

Available Models

Suffix:

- QT – quarter-turn ball valves
- S – bronze strainer

Materials

Body: Lead Free* Cast Copper Silicon Alloy

Discs: Silicone rubber

Check Seats: Replaceable polymer

Cover Bolts: Stainless steel

Approvals



Approved by the Foundation for Cross-Connection Control and Research at The University of Southern California. (for sizes 1/4"-2")

Pressure – Temperature

Temperature Range: 33°F – 180°F (0.5°C – 82°C)

Maximum Working Pressure: 175psi (12.1 bar)

Air Gaps

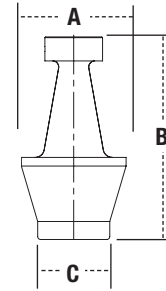

AIR GAP MODEL	SIZES	DIMENSIONS			WEIGHT	
		A in. mm	B in. mm	C (NPT) in. mm	lbs.	kg.
919AGC	1/4" – 1"	2 3/8 60	3 1/8 79	1/2 13	.63	.28
919AGF	1 1/4" – 2"	4 3/8 111	8 7/16 214	2 50	3.5	1.6

Dimensions – Weights

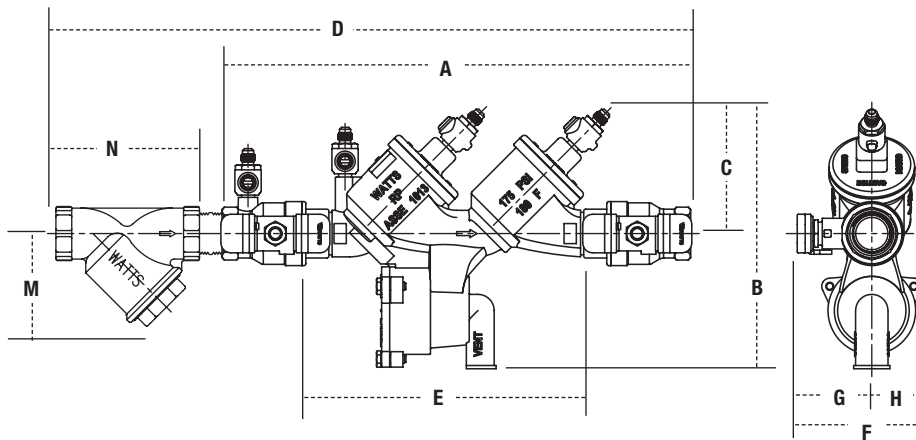

LF919QT, LF919QT-S

SIZE (DN)		DIMENSIONS						STRAINER DIMENSIONS				WEIGHT											
in.	mm	A in.	B mm	C in.	D mm	E (LF) in.	F mm	G in.	H mm	M in.	N mm	lbs.	kg.										
1/2	15	9 1/2	241	6 7/8	175	2 7/8	73	12 3/4	324	5 3/4	146	3 3/8	86	1 7/8	48	1 9/16	40	2 3/4	70	2 1/4	57	5.8	2.6
3/4	20	12 1/8	307	7 7/16	188	3 1/2	88	15 1/2	393	7 11/16	195	3 5/8	92	2 1/16	52	1 9/16	40	1 5/8	41	3 3/16	81	8.3	3.7
1	25	14 1/2	368	8	202	3 7/8	98	19 3/16	487	9 3/16	233	4	102	2 7/16	62	1 9/16	40	2 1/8	54	3 3/4	95	11.8	5.4
1 1/4	32	18 1/8	461	11 7/16	290	5 1/8	129	23 1/4	591	11 11/16	297	5 1/8	130	2 5/8	67	2 1/2	64	2 1/2	64	4 7/16	113	22.3	10.1
1 1/2	40	18 3/4	476	11 7/16	290	5 1/8	129	25 1/16	637	11 11/16	297	5 5/8	143	3 1/8	79	2 1/2	64	3	76	4 7/8	124	28.3	12.8
2	50	21 1/16	535	12 1/16	307	5 5/8	142	28 13/16	732	13 3/8	340	5 15/16	151	3 7/16	87	2 1/2	64	3 9/16	90	5 15/16	151	37.3	16.9

Capacities

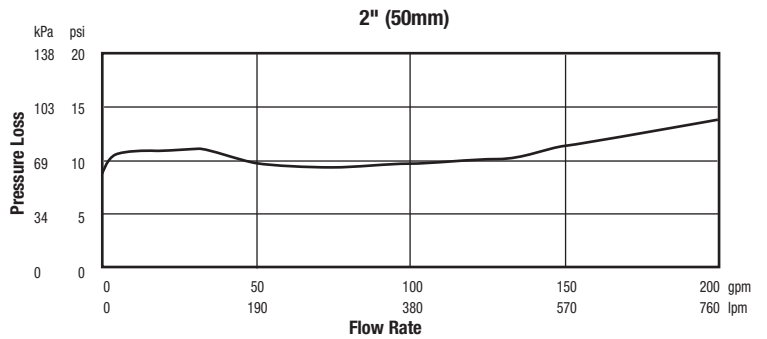
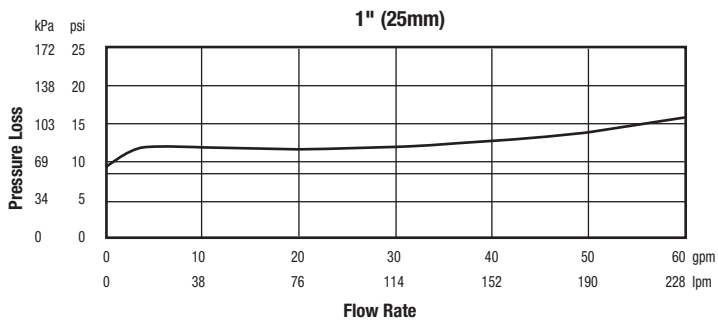
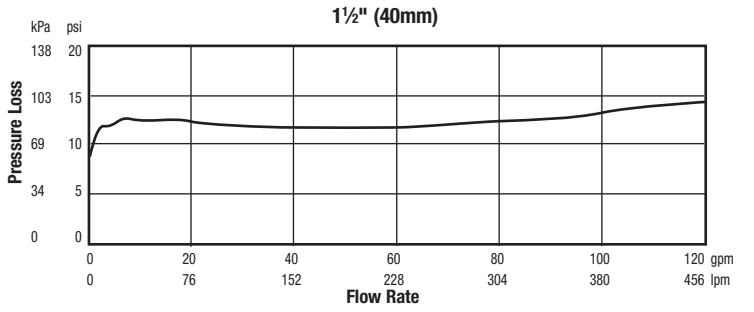
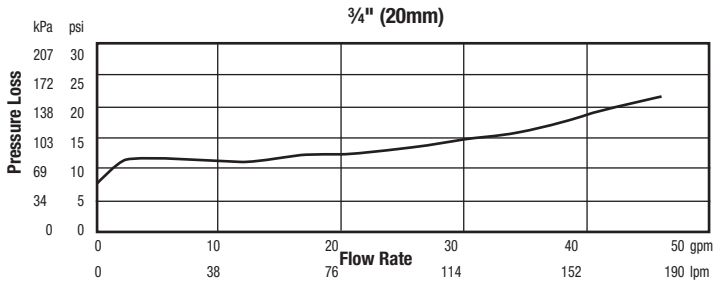
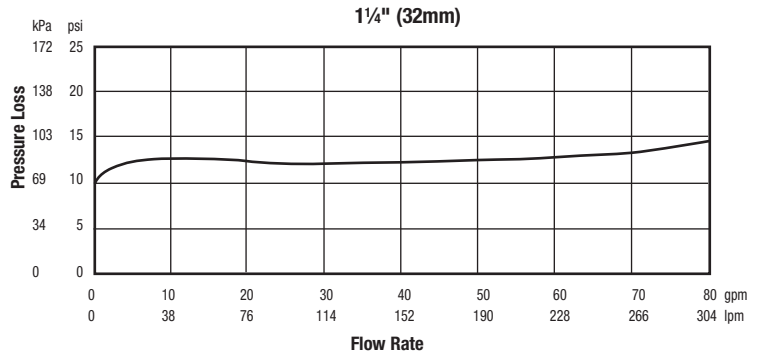
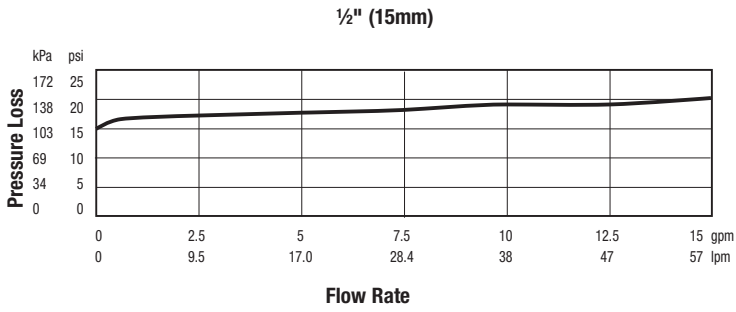

A Watts Water Technologies Company



ISO 9001-2008
CERTIFIED

USA: Tel: (978) 688-1811 • Fax: (978) 794-1848 • www.watts.com
Canada: Tel: (905) 332-4090 • Fax: (905) 332-7068 • www.watts.ca